

3-Way Pressure-Reducing Cartridge, Size 2...4

$Q_{\max} = 20 \text{ l/min}$, $p_{\max} = 250 \text{ bar}$

Spool-type design, direct acting, with manual adjustment

Series DDRB-7M...



- Compact construction for cavity type AM – 3/4-16 UNF to Bucher standards
- 5 pressure ranges available
- Full-flow secondary pressure relief
- Excellent stability over the whole pressure and flow range
- Available with hand-knob
- All exposed parts with zinc-nickel plating
- Can be fitted in a line-mounting body

1 Description

Series DDRB-7M... screw-in cartridges are direct acting, spool-type high performance 3-way pressure-reducing valves. They are available in sizes 2...4 and have a 3/4-16 UNF mounting thread. The straightforward design delivers an outstanding price/performance ratio and good pressure/flow ratings. The valves control the required secondary pressure in port 3 to the value set with the pressure adjustment, and independently of the inlet pressure in port 2. In control mode, the connection 2 → 3 opens until the pressure in port 3 reaches the preset level. If the pressure rises above the preset level, the control spool opens the 3 → 1 connection until balance is restored. These 3-way pres-

sure-reducing cartridges function as full-flow pressure relief valves from port 3 → 1 as soon as the reduced pressure rises above the valve pressure setting. Five spring ranges are available in order to obtain precise pressure settings over the whole of the required pressure range. These 3-way pressure-reducing cartridges are predominantly used in mobile and industrial applications for reducing a system pressure. All external parts of the cartridge are zinc-nickel plated to DIN 50 979 and are thus suitable for use in the harshest operating environments. If you intend to manufacture your own cavities or are designing a line-mounting installation, please refer to the section "Related data sheets".

2 Symbol

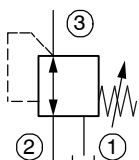

3 Technical data

General characteristics	Description, value, unit
Designation	3-way pressure-reducing cartridge
Design	Spool-type design, direct acting, with manual adjustment
Mounting method	screw-in cartridge 3/4-16 UNF
Tightening torque	50 Nm ± 10 %
Size	nominal size 2...4, cavity type AM
Weight	0.20 kg
Mounting attitude	unrestricted
Ambient temperature range	-25 °C ... +80 °C

Hydraulic characteristics	Description, value, unit
Maximum operating pressure	250 bar
Maximum flow rate	20 l/min
Nominal pressure ranges	30 bar, 60 bar, 100 bar, 160 bar, 250 bar
Pressure adjustment range	- 250 bar 0 ... 250 bar (1 turn \approx 43 bar) - 160 bar 0 ... 160 bar (1 turn \approx 24 bar) - 100 bar 0 ... 100 bar (1 turn \approx 19 bar) - 60 bar 0 ... 60 bar (1 turn \approx 13 bar) - 30 bar 0 ... 30 bar (1 turn \approx 5 bar)
Leakage flow rate	< 40 cm ³ /min (with p ₂ 250 bar) with oil viscosity 33 mm ² /s (cSt)
Flow direction	see symbol
Hydraulic fluid	HL and HLP mineral oil to DIN 51 524; for other fluids, please contact BUCHER
Hydraulic fluid temperature range	-25 °C ... +80 °C
Viscosity range	10...650 mm ² /s (cSt), recommended 15...250 mm ² /s (cSt)
Minimum fluid cleanliness Cleanliness class to ISO 4406 : 1999	class 20/18/15

4 Performance graphs

measured with oil viscosity 33 mm²/s (cSt)

$p = f(Q)$ Pressure - Flow rate characteristic [p_N = 30 bar]

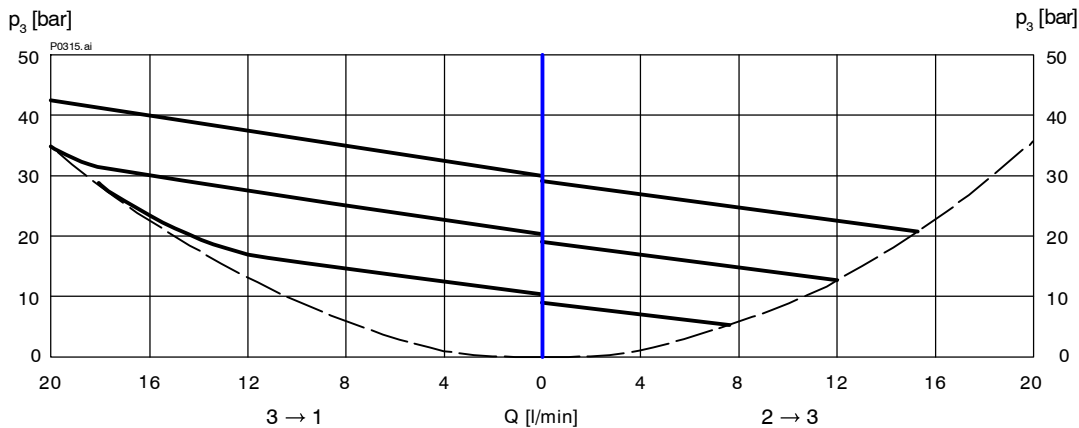

$p = f(Q)$ Pressure - Flow rate characteristic [p_N = 60 bar]

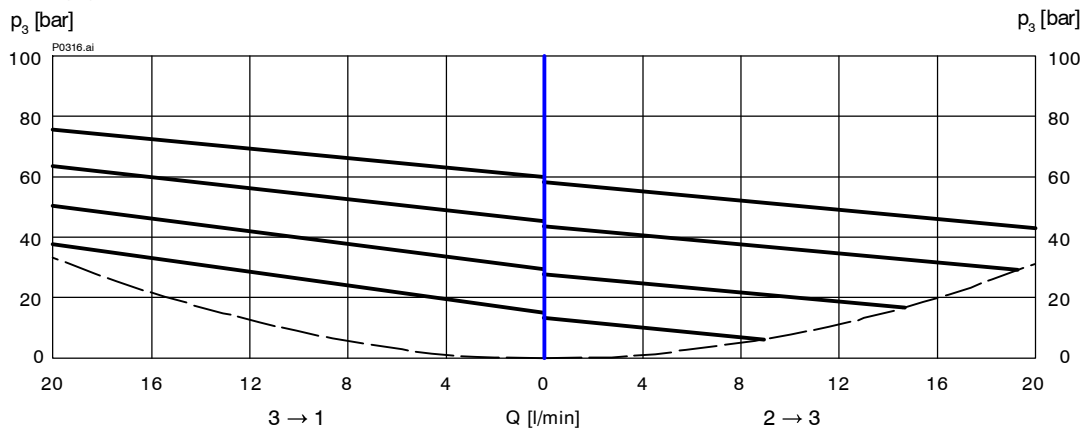

$p = f(Q)$ Pressure - Flow rate characteristic [$p_N = 100 \text{ bar}$]

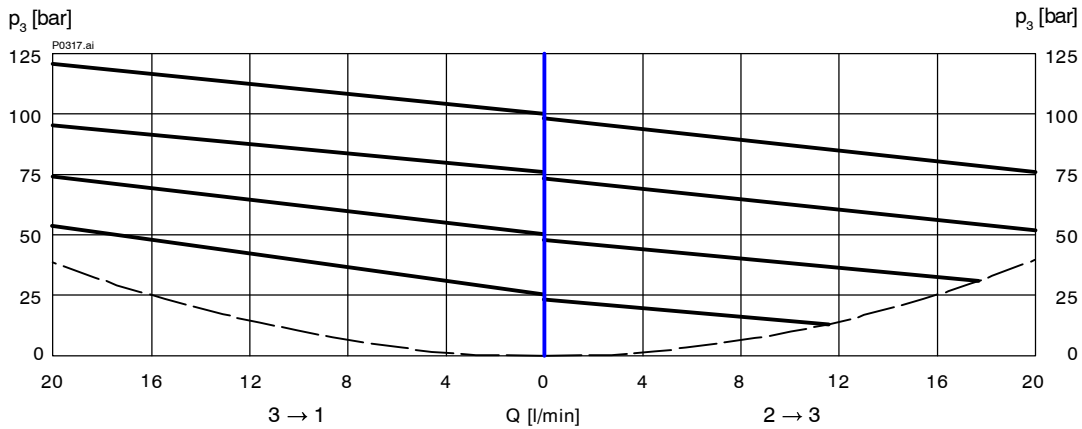

$p = f(Q)$ Pressure - Flow rate characteristic [$p_N = 160 \text{ bar}$]

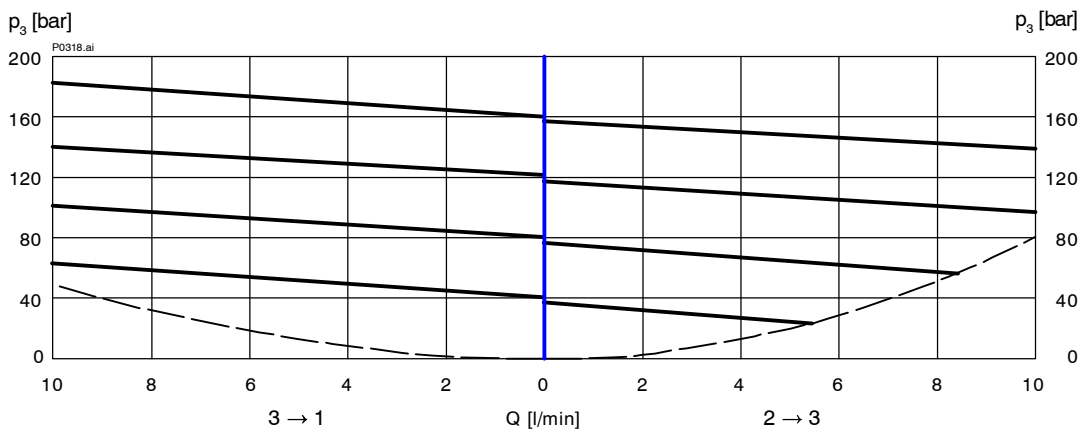

$p = f(Q)$ Pressure - Flow rate characteristic [$p_N = 250 \text{ bar}$]

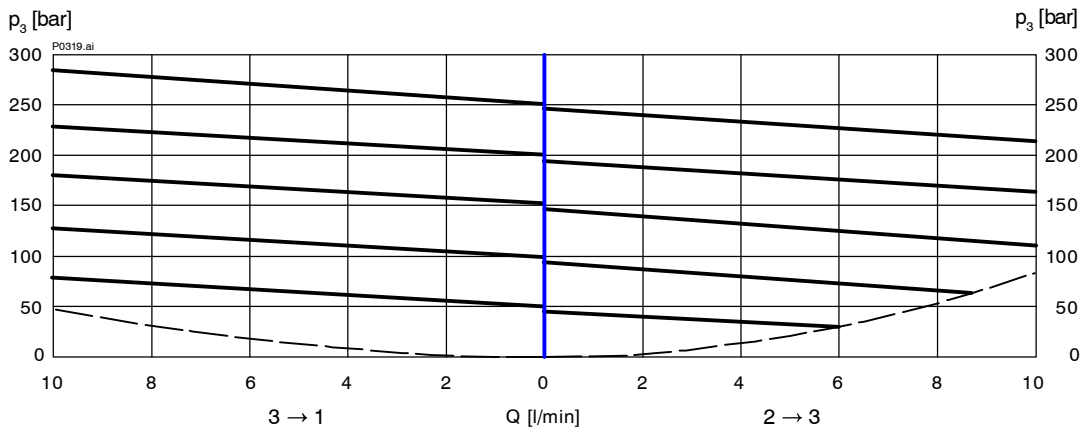

5 Dimensions & sectional view

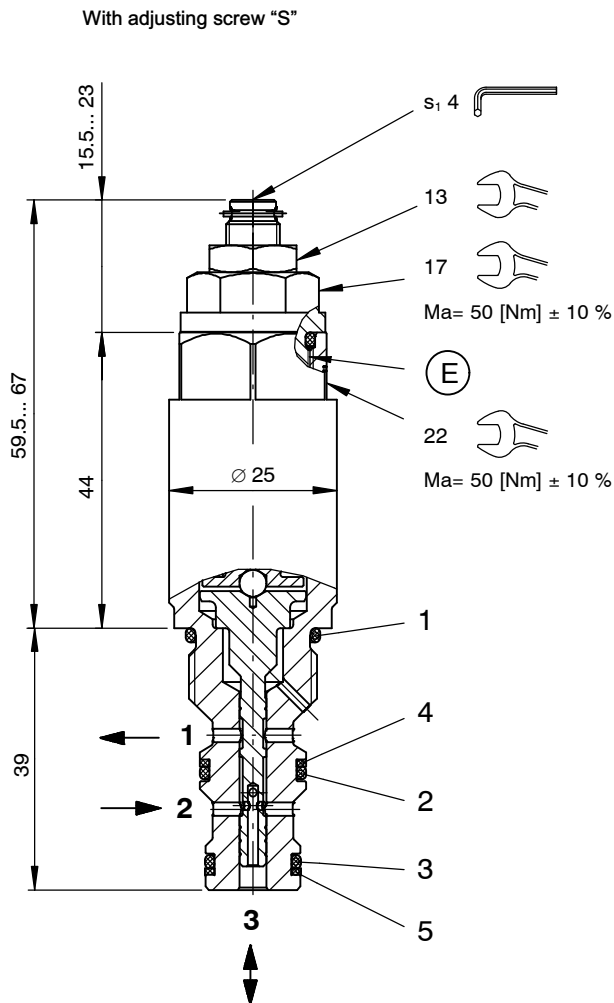

With hand-knob adjuster "H"

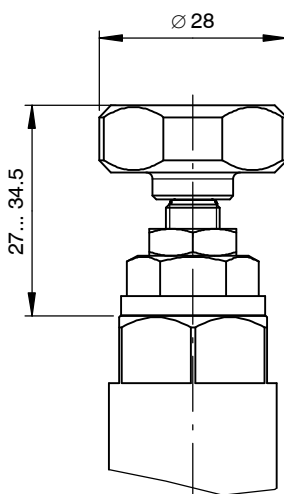

6 Installation information



IMPORTANT!

When fitting the cartridges, use the specified tightening torque. Set the required pressure with the adjusting screw (s_1). After you have set the valve, lock the adjusting screw with the lock nut.



IMPORTANT!

Air-bleeding: If necessary, air can be purged from these 3-way pressure-reducing cartridges by using the integral bleed groove (Item E). The procedure is as follows:

Steps:

4. Slacken the air-bleed screw (17 A/F) approx. 2 turns.
5. Switch the cartridge (ON/OFF) several times until no more air bubbles escape.
6. Tighten (Ma = 50 Nm \pm 10 %) the air-bleed screw.



ATTENTION!

Only qualified personnel with mechanical skills may carry out any maintenance work. Generally, the only work that should ever be undertaken is to check, and possibly replace, the seals. When changing seals, oil or grease the new seals thoroughly before fitting them.

Seal kit NBR no. DS-249-N ¹⁾

Item	Qty.	Description
1	1	O-ring no. 017 $\varnothing 17,17 \times 1,78$ N90
2	1	O-ring no. 014 $\varnothing 12,42 \times 1,78$ N90
3	1	O-ring no. 013 $\varnothing 10,82 \times 1,78$ N90
4	2	Backup ring $\varnothing 10,70 \times 1,45 \times 1,0$ FI0751
5	2	Backup ring $\varnothing 09,40 \times 1,45 \times 1,0$ FI0751



IMPORTANT!

¹⁾ Seal kit with FKM (Viton) seals, no. DS-249-V

7 Ordering code

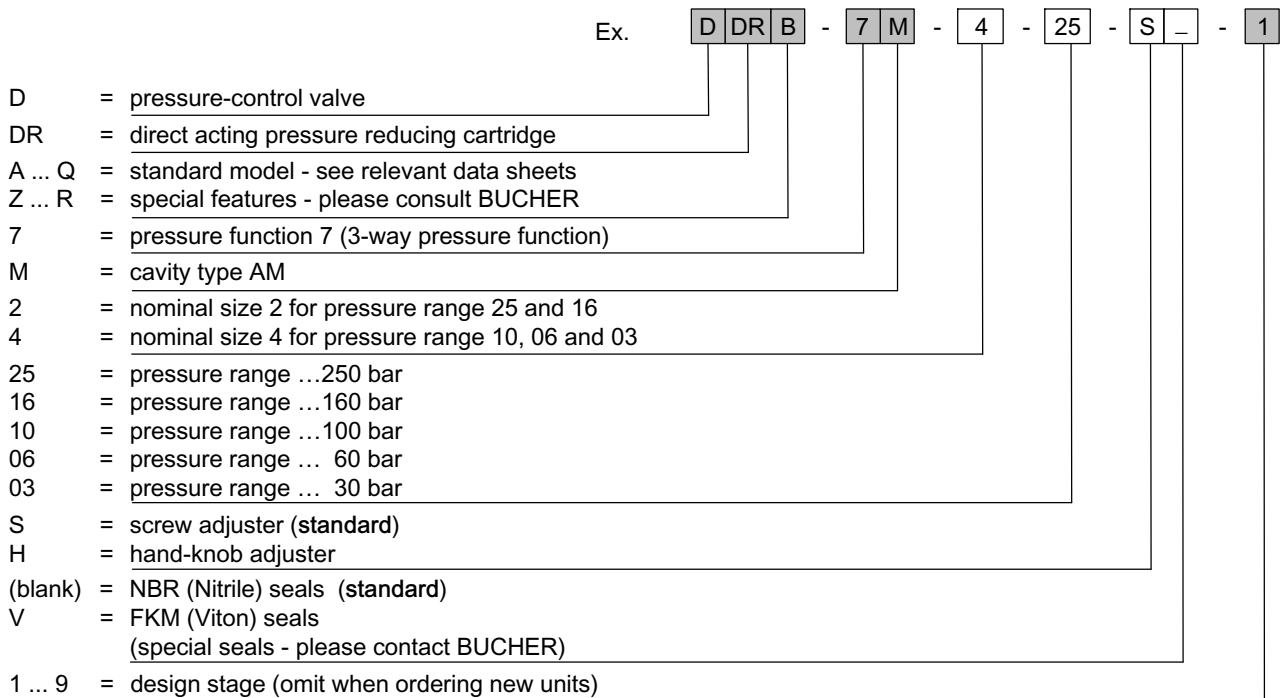

8 Related data sheets

Reference	(Old no.)	Description
400-P-040011	(i-32)	The form-tool hire programme
400-P-040181		Cavity type AM
400-P-720111		Line-mounting body, type GAMA (G 3/8")

info.ch@bucherhydraulics.com

www.bucherhydraulics.com

© 2015 by Bucher Hydraulics AG Frutigen, CH-3714 Frutigen

All rights reserved.

Data is provided for the purpose of product description only, and must not be construed as warranted characteristics in the legal sense. The information does not relieve users from the duty of conducting their own evaluations and tests. Because the products are subject to continual improvement, we reserve the right to amend the product specifications contained in this catalogue.

Classification: 430.305.305.305.355